

Z & L Bracket – A Series – 300LBS

FEATURES

- Easy to locate the armature plate
- Collocation with electromagnetic locks to fit with customers installation environments
- Applicable for in-swing door
- Firm & Durable



SPECIFICATION	
Material	Aluminium
Finish	Anodized finish

INSTALLATION:

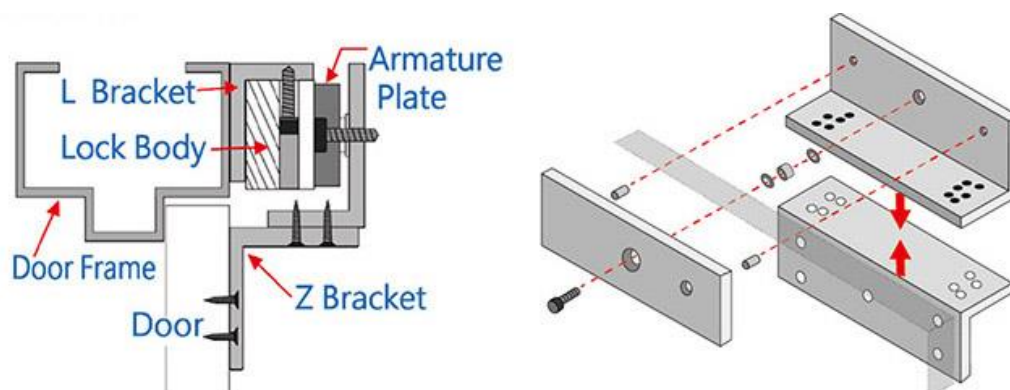

DIMENSION:

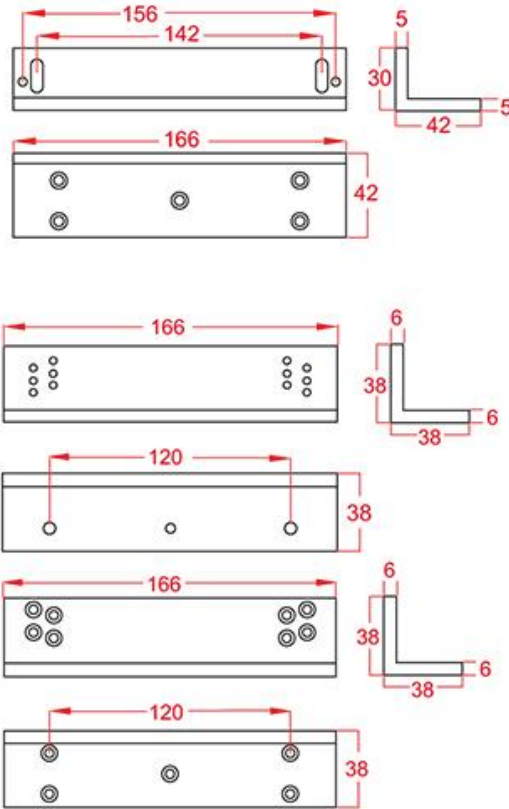

ORDERING INFORMATION

RDZL03A

Z & L Bracket for 300 LBS Maglock